

TV only

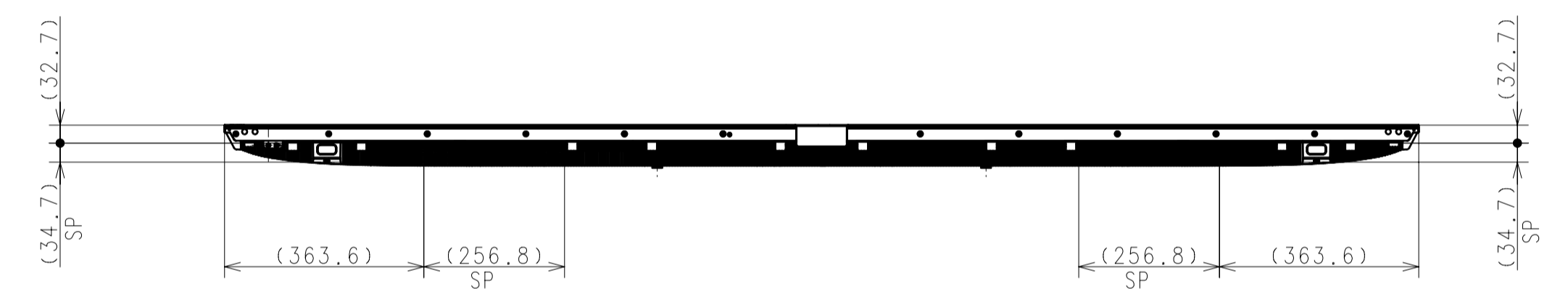

M8 HOLES FOR WALL MOUNT BRACKET
 *REFER TO INSTRUCTION MANUAL FOR SCREW LENGTH INFORMATION

M8 HOLES FOR SECURING HARDWARE.
 (BELT, ROPE OR CHAIN)

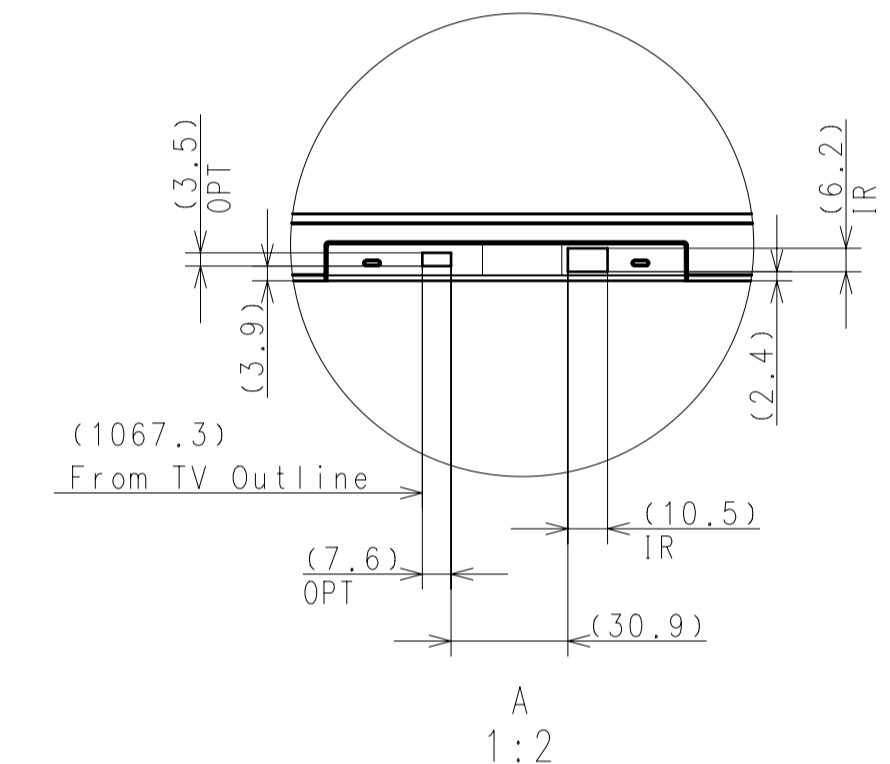
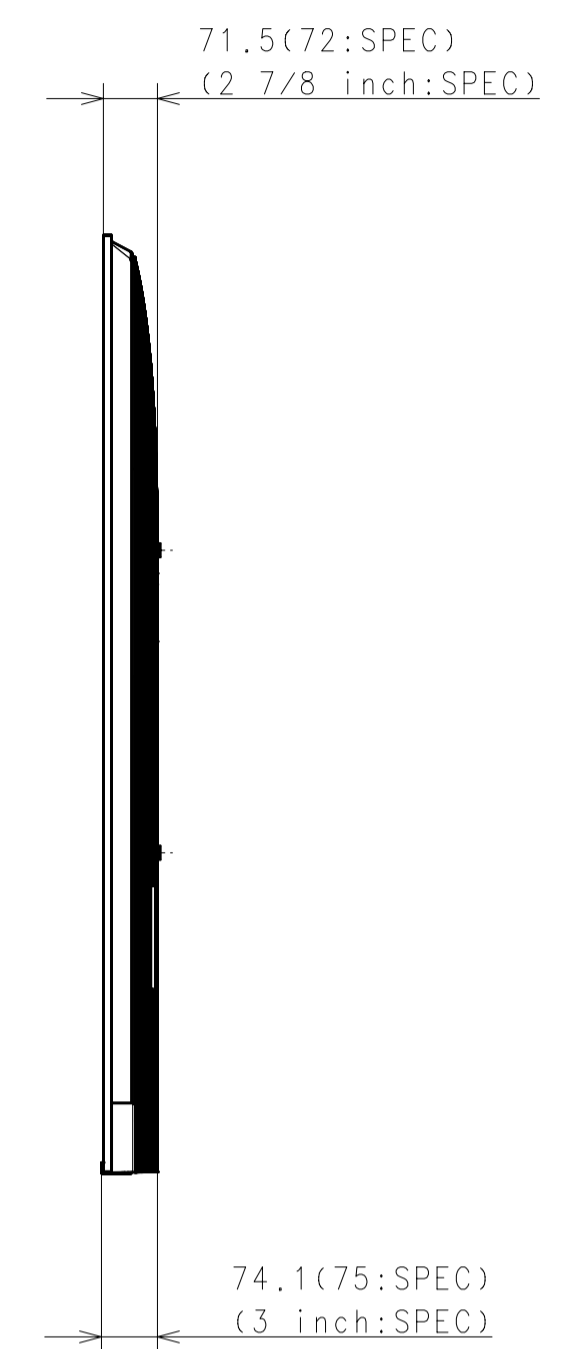
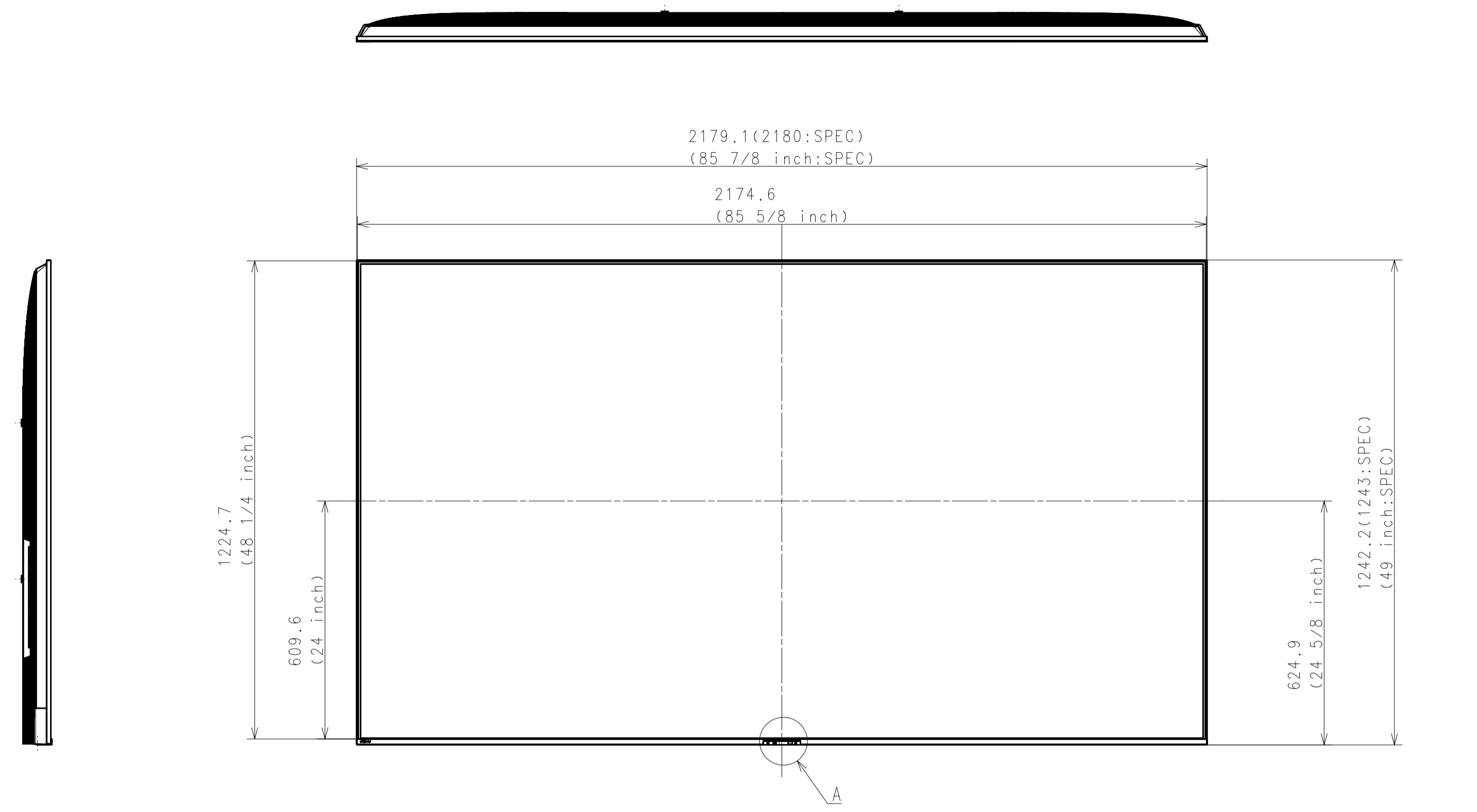
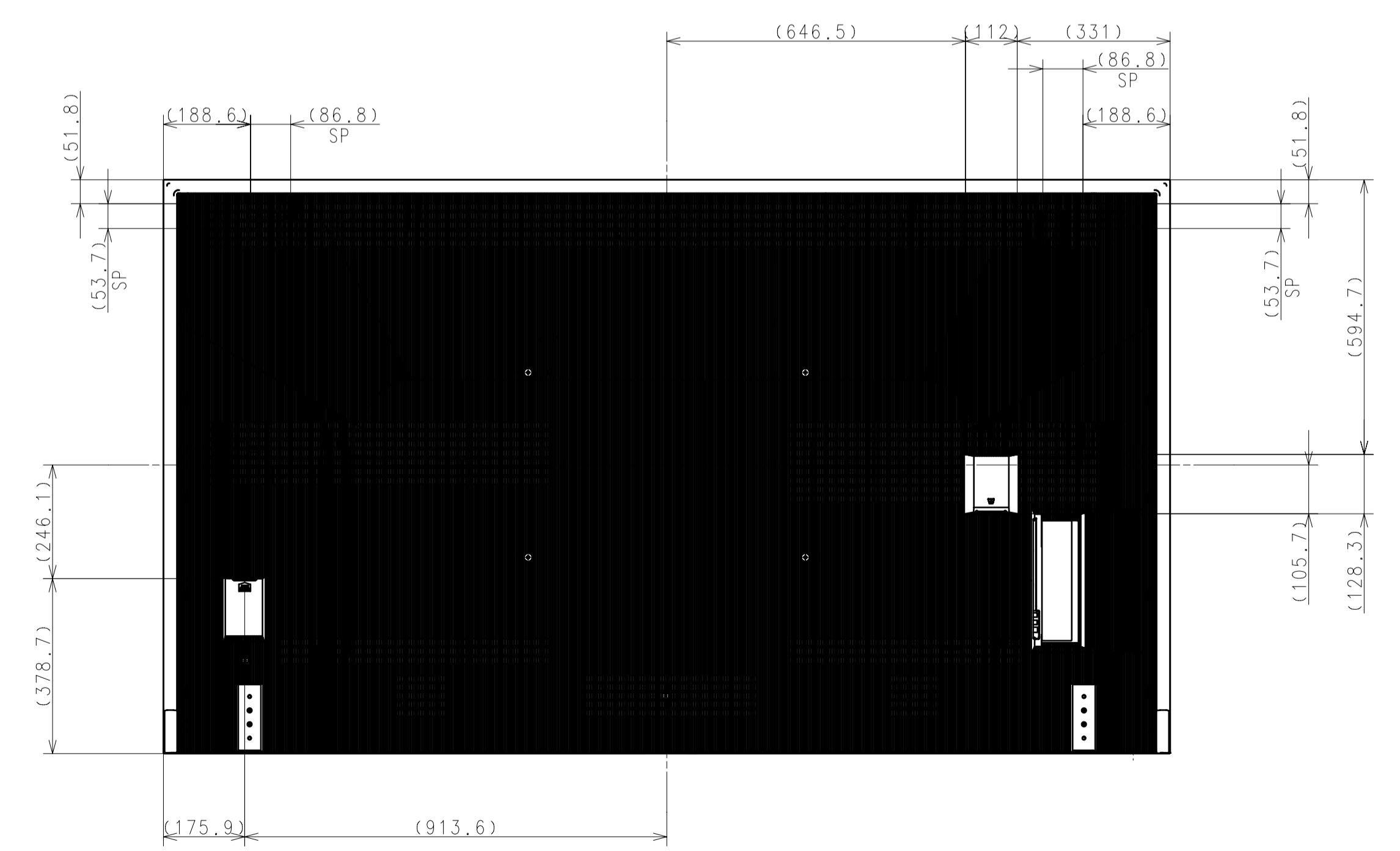
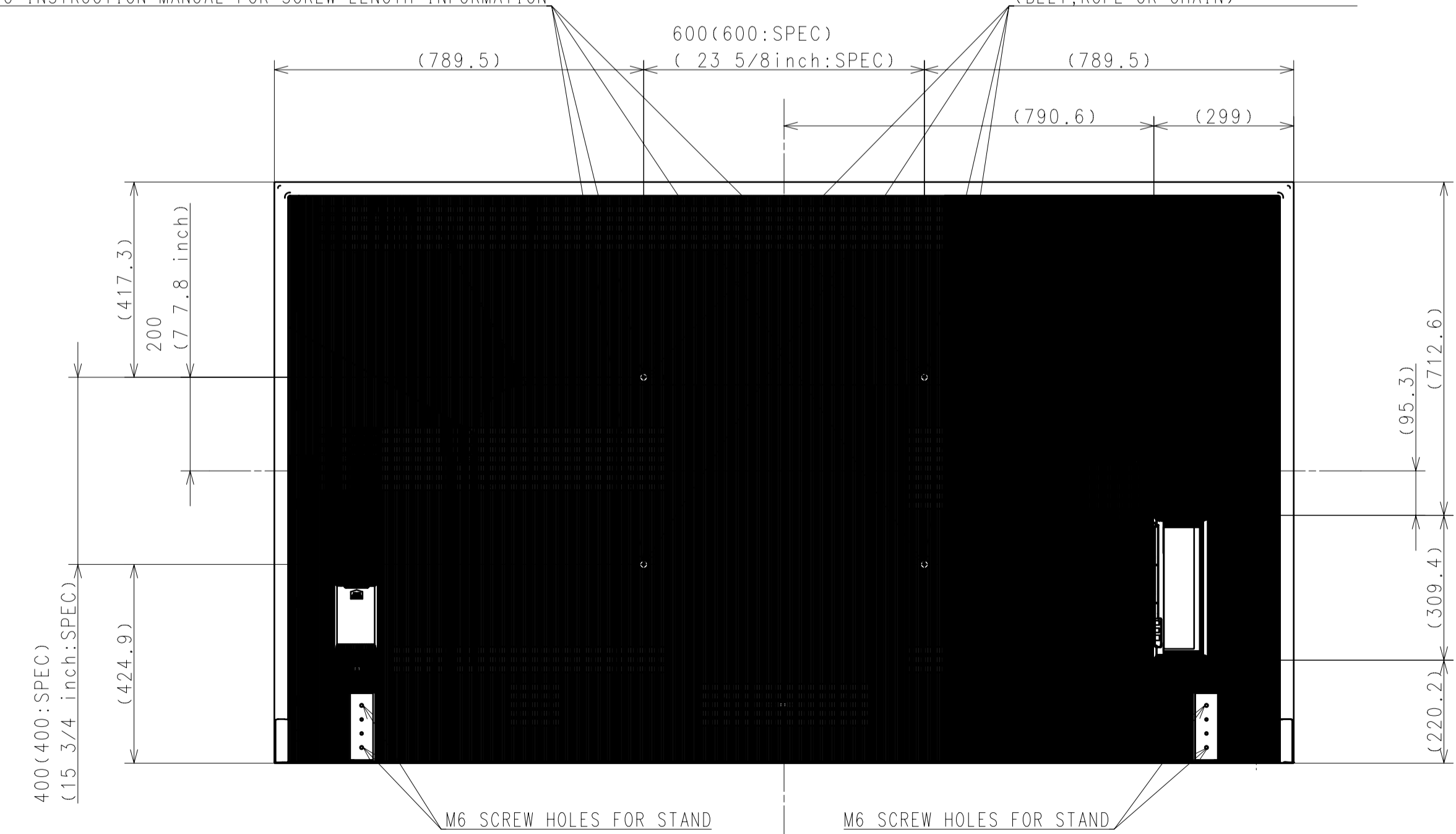

FOR EXCEPT EU

FOR EU

DESCRIPTION 1	98(XR70M2) EXTERIOR VIEW	LEGAL OWNER	Sony Corporation	SCALE	1:10
DESCRIPTION 2	98(XR70M2) EXTERIOR VIEW	PART NO.		SHEET/PAGES	2 / 3

SU-WL460

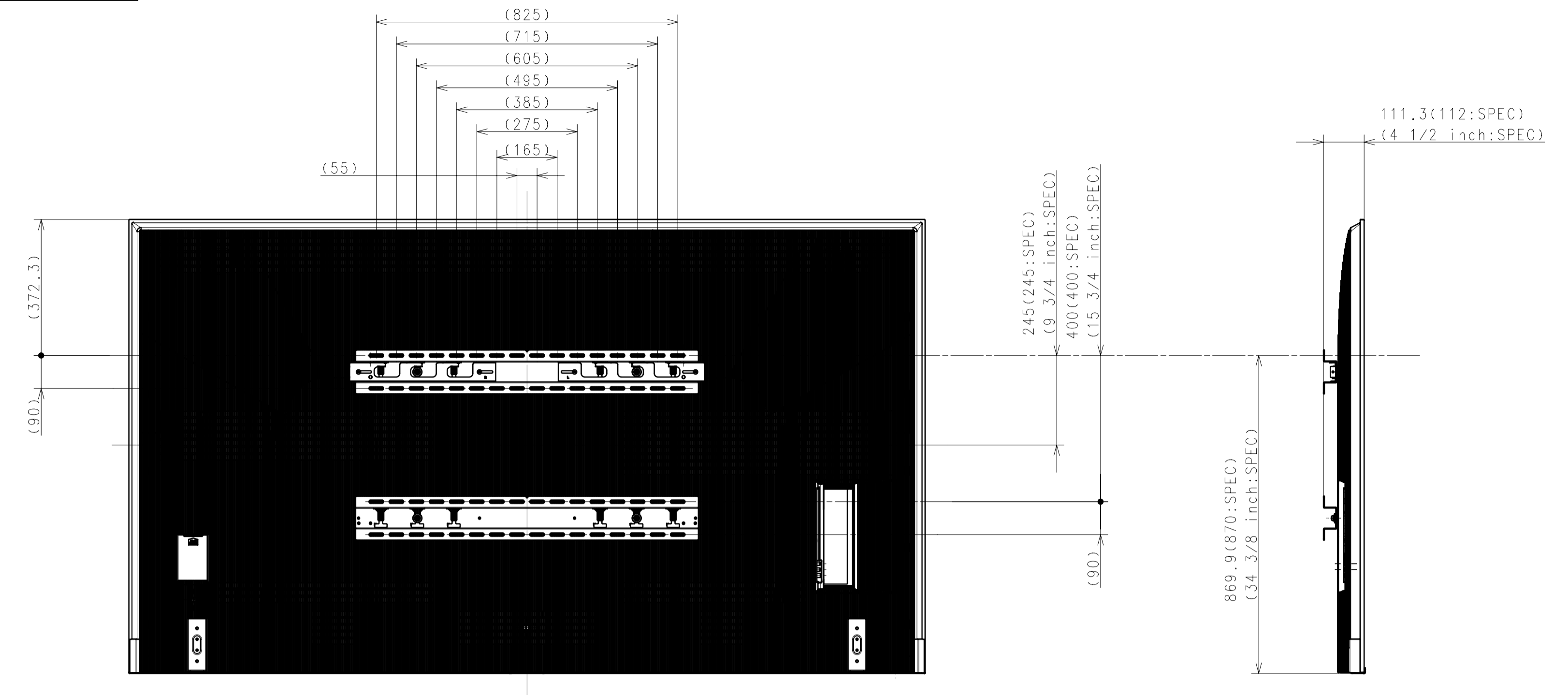

SONY STANDARD DRAWING

DESCRIPTION 1	LEGAL OWNER	SCALE
98(XR70M2) EXTERIOR VIEW	Sony Corporation	1:1
DESCRIPTION 2	PART NO.	SHEET/PAGES
98(XR70M2) EXTERIOR VIEW		3 / 3